



E	Instrucción de montaje ¡Leer primero!	Accesorio
GB	Assembly instructions Read first!	Accessory
F	Instruction de montage Lire en premier!	Accessoire
D	Montageanleitung Zuerst lesen!	Zubehör
PT	Instruções de montagem Ler primeiro!	Accesório
PL	Instrukcja montażu Najpierw przeczytaj!	Wyposażenie
CZ	Montážní návod Čtěte pozorně!	Příslušenství
HU	Szerelési Utasítás Először olvasd el!	Kiegészítő
RO	Instrucțiuni de montaj Intai cititi!	Dodaci
HR	Detaljne upute Prvo pročitati!	Accesoriju
GR	Διαβάστε προσεκτικά τις Οδηγίες Συναρμολόγησης!	Αξεσουάρ
TR	Öncelikli montaj: Talimatlarını okuyunuz!	Aksesuar
RU	Инструкции по монтажу Сначала прочитайте!	Аксессуары
I	Istruzioni di montaggio Leggere per primo!	Accessori
NL	Montagehandleiding Eerst lezen!	Accessoires
SLO	Navodila za sestavljanje Preberite!	Dodatek

940-403

2016-r1

Modelo-model:

Cruz Lift

Lote-Lot-Lot-Lot:

01-16

Peso-Weight-Poids-Gewicht:

1,6 kg



Max: 30 kg

Cruzber SA
ES-A14018311
P.I. Las Salinas II
14960 - Rute - Spain
www.cruzber.com



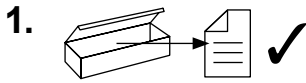

A  x 2



G 

B  x 4

E  x 2

H 

C  x 2

F 



Para techos con ladrillo hueco.
Tasselli per mattone vuoto.
Pour plafond avec brique vides.
For ceiling with empty bricks.
Do sufitu z pustakow stropowych.

I 

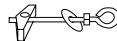
L  x 4

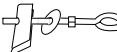
M  x 2

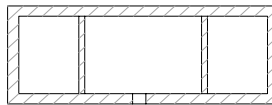

Para techos con ladrillo mazizo.
Tasselli per mattone pieno.
Pour plafond avec brique pleines.
For ceiling with full bricks.
Do sufitu z cegly pelnej.

N  x 6

O 

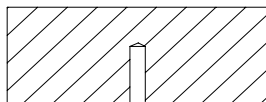

Importante!
Important!
Important!
Wichtig!

(E)

Antes de instalar hay que revisar el material del techo para asegurarse de que es adecuado y suficientemente resistente para soportar el peso.

(GB)

Before installing the ceiling material must be checked to ensure that it is suitable and strong enough to support the weight.

(F)

Avant l'installation le matériau du plafond doit être contrôlé afin de vérifier qu'il est approprié et suffisamment résistant pour soutenir la charge.

(D)

Vor dem Anbringen muss das Deckenmaterial auf Eignung zur Befestigung geprüft werden.

2. 

1



TECHO - SOFFITTO - PLAFOND - CEILING - SUFIT

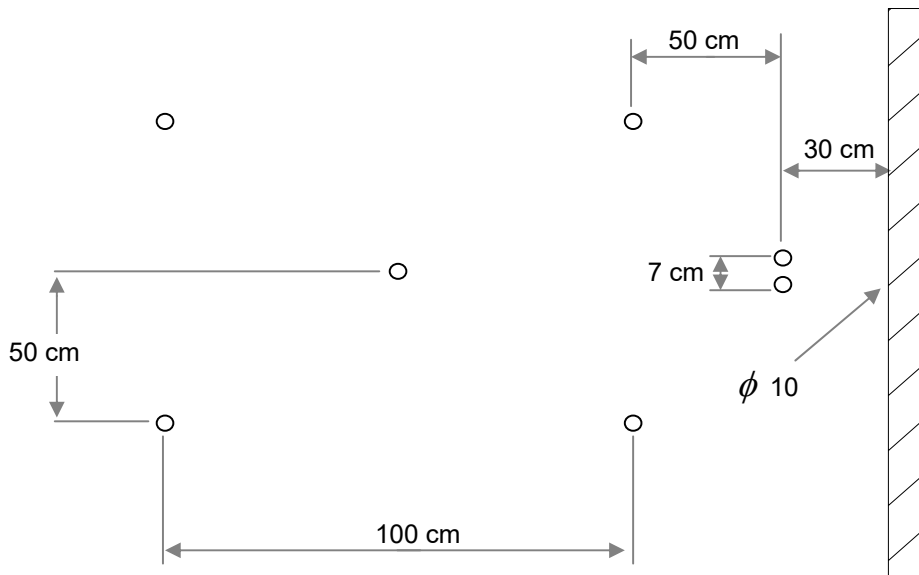

ϕ 16



ϕ 10

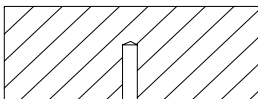

3. 

2

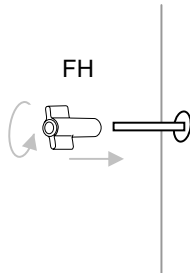
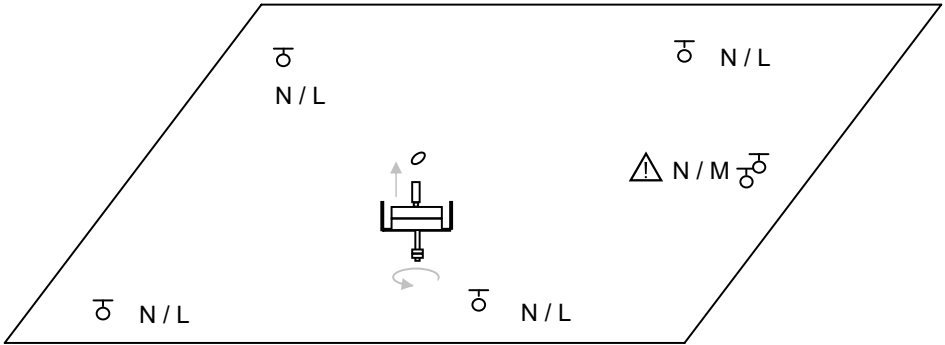
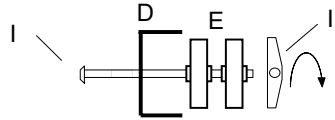
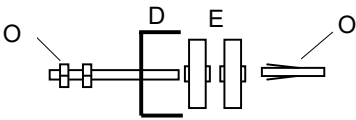
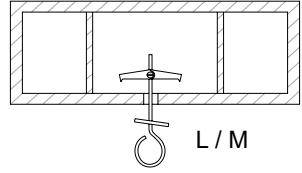
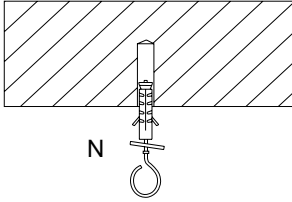

4. 

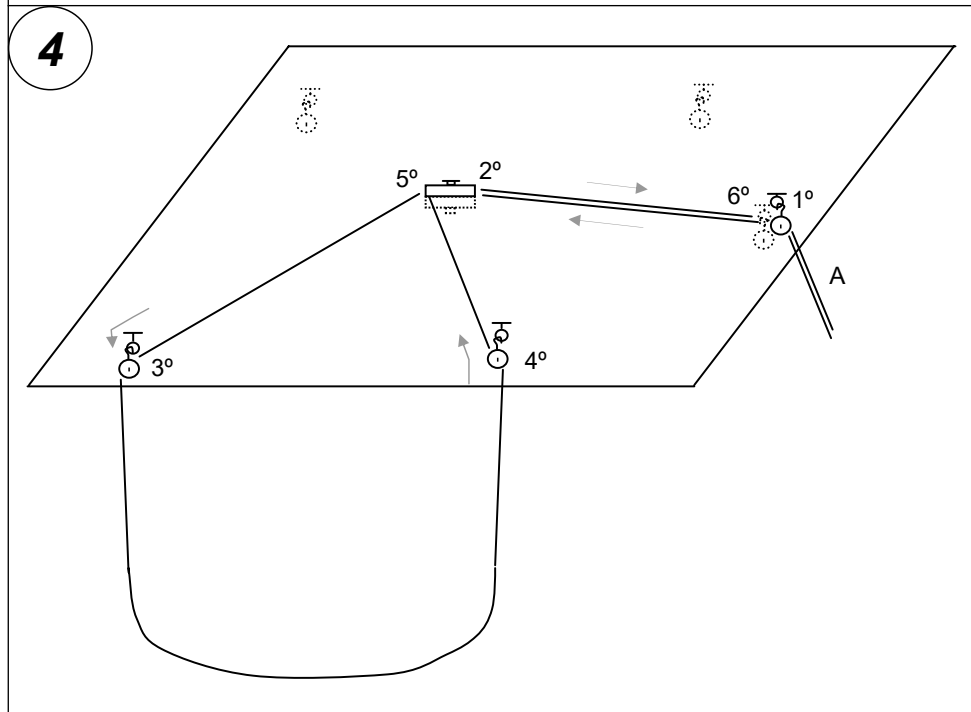
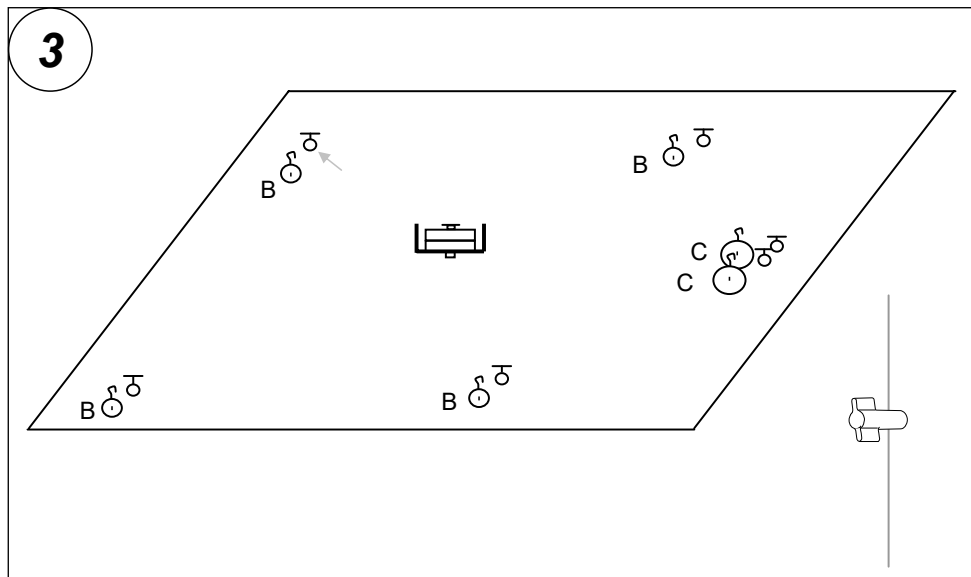

5. 

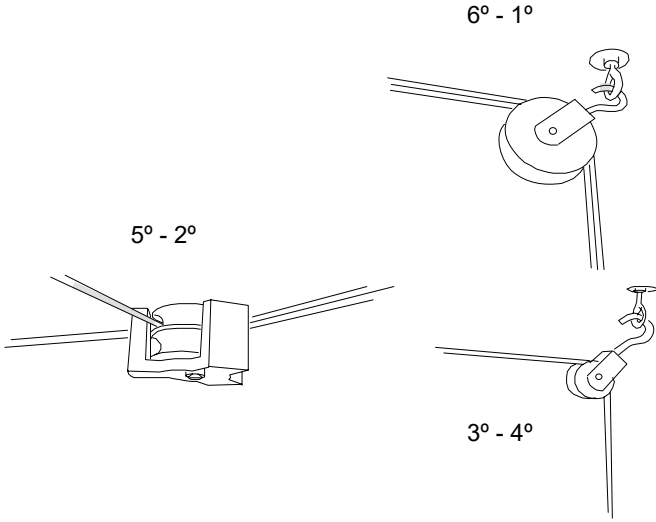

5

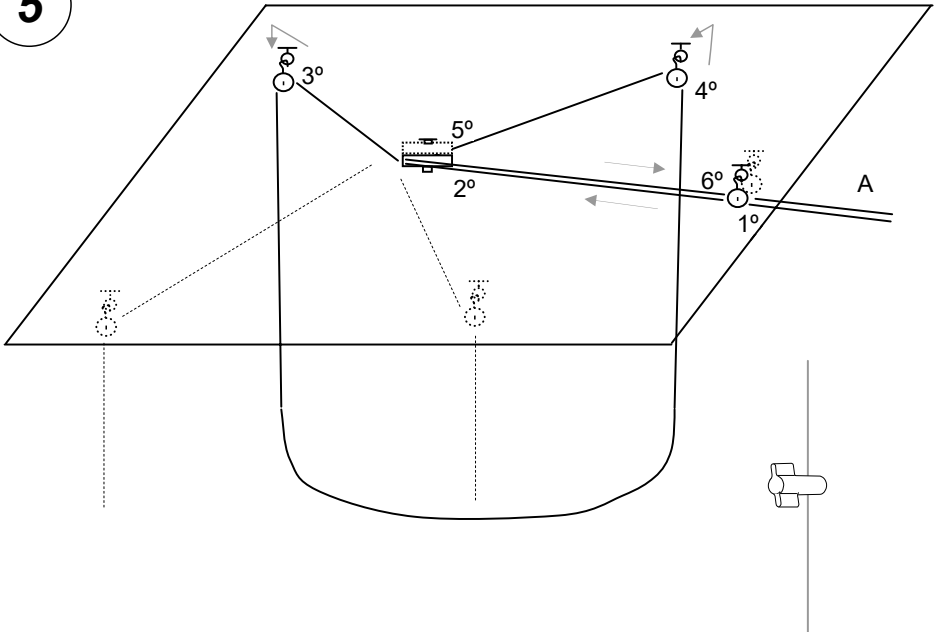

6. 

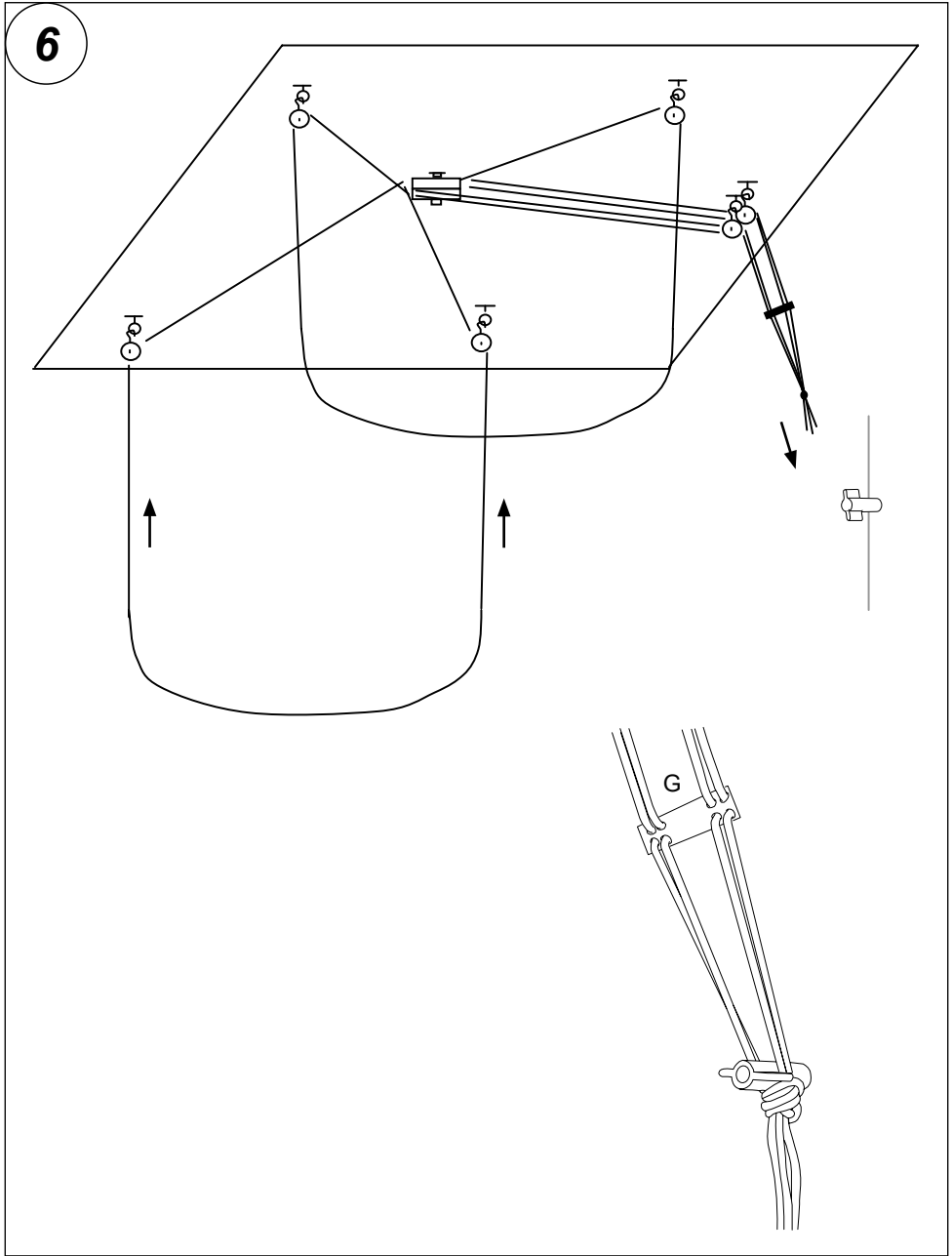

7. 