



- | | | |
|-------|---|-------------------------|
| (E) | Instrucción de montaje
¡Leer primero! | Kit fijación |
| (GB) | Assembly instructions
Read first! | Fixation Kit |
| (F) | Instruction de montage
Lire en premier! | Kit fixation |
| (D) | Montageanleitung
Zuerst lesen! | Stützfuß-Kit |
| (PT) | Instruções de montagem
Ler primeiro! | Kit fixação |
| (PL) | Instrukcja montażu
Najpierw przeczytaj! | Element mocujący |
| (CZ) | Montážní návod
Čtěte pozorně! | Fixační kit |
| (HU) | Szerelési Utasítás
Először olvasd el! | Rögzítő készlet |
| (RO) | Instructiuni de montaj
Intai cititi! | Kit de fixare |
| (HR) | Detaljne upute
Prvo pročitati! | Kit za montažu |
| (GR) | Διαβάστε προσεκτικά τις
Οδηγίες Συναρμολόγησης! | Κιβώτιο (Kit) Επισκευής |
| (TR) | Öncelikle montaj:
Talimatlarını okuyunuz! | Montaj kiti |
| (RU) | Инструкции по монтажу
Сначала прочитайте! | Крепежный комплект |
| (I) | Istruzioni di montaggio
Leggere per primo! | Kit di fissaggio |
| (NL) | Montagehandleiding
Eerst lezen! | Bevestigingsset |
| (SLO) | Navodila za sestavljanje
Preberite! | Kit za pričvrstitev |

936-045

Lv7 2022-r1

Modelo-model:

Optiplus FIX

Lote-Lot-Lot-Lot:

01-22

Peso-Weight-Poids-Gewicht:

0,63 kg



Kit tipo (Certificación)
Kit type (Certification)
Kit type (Certificat)
Kit Typ (Zertifizierung)

C

CEE - EEC type approval:



26 R- 04 3015

CRUZBER SA
ES-A14018311
P.I. Las Salinas II
14960 - Rute - Spain
www.cruzber.com



1.



x1



x1



(018-041)

x2



1x (802-003)
1x (810-045)

x4

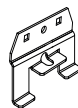

1x (3539)
1x (3540)
1x (3541)
1x (3542)

x4

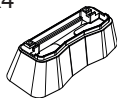

1x (012-176)
1x (012-177)
1x (012-178)
1x (012-179)



Importante!
Important!
Important!
Wichtig!

(PL) Niniejszy element mocujący musi być używany z systemami bagażników dachowych firmy Cruz!

(TR) Bu aksesuar mutlaka Cruz taşıma sistemleriyle kullanılmalıdır!

(E) ¡Este Kit de fijación tiene que usarse con sistemas portacargas Cruz!

(CZ) Tento fixační kit musí být používán s nosným systémem Cruz!

(RU) Крепежный комплект должен быть использован с багажной системой на крышу марки Cruz!

(GB) This fixation Kit must be used with Cruz roof rack systems!

(HU) Ez a rögzítő készlet csak a Cruz rendszerekkel használható!

(IT) Questo kit di fissaggio deve essere usato con i portapacchi Cruz

(F) Cet Kit de fixation devra être utilisé avec les systèmes porte-charge Cruz!

(RO) Acest Kit de fixare, trebuie utilizat cu sisteme Cruz!

(NL) Deze bevestigingsset moet worden gebruikt in combinatie met Cruz dakdrager systeem!

(D) Dieser Stützfuß-Kit muß mit Cruz Dachträgersystemen benutzt werden!

(HR) Kit za montažu mora biti korišten uz Cruz sistem krovnog nosača!

(SLO) Kit za pričvrstitev naj se uporablja le z izdelki iz asortimana strešnih košar Cruz!

(PT) Este Kit de fixação deve ser utilizado com os sistemas porta cargas Cruz!

(GR) Το αξεσουάρ αυτό θα πρέπει να χρησιμοποιείται αποκλειστικά στα συστήματα μπαρών της Cruz!

2. 

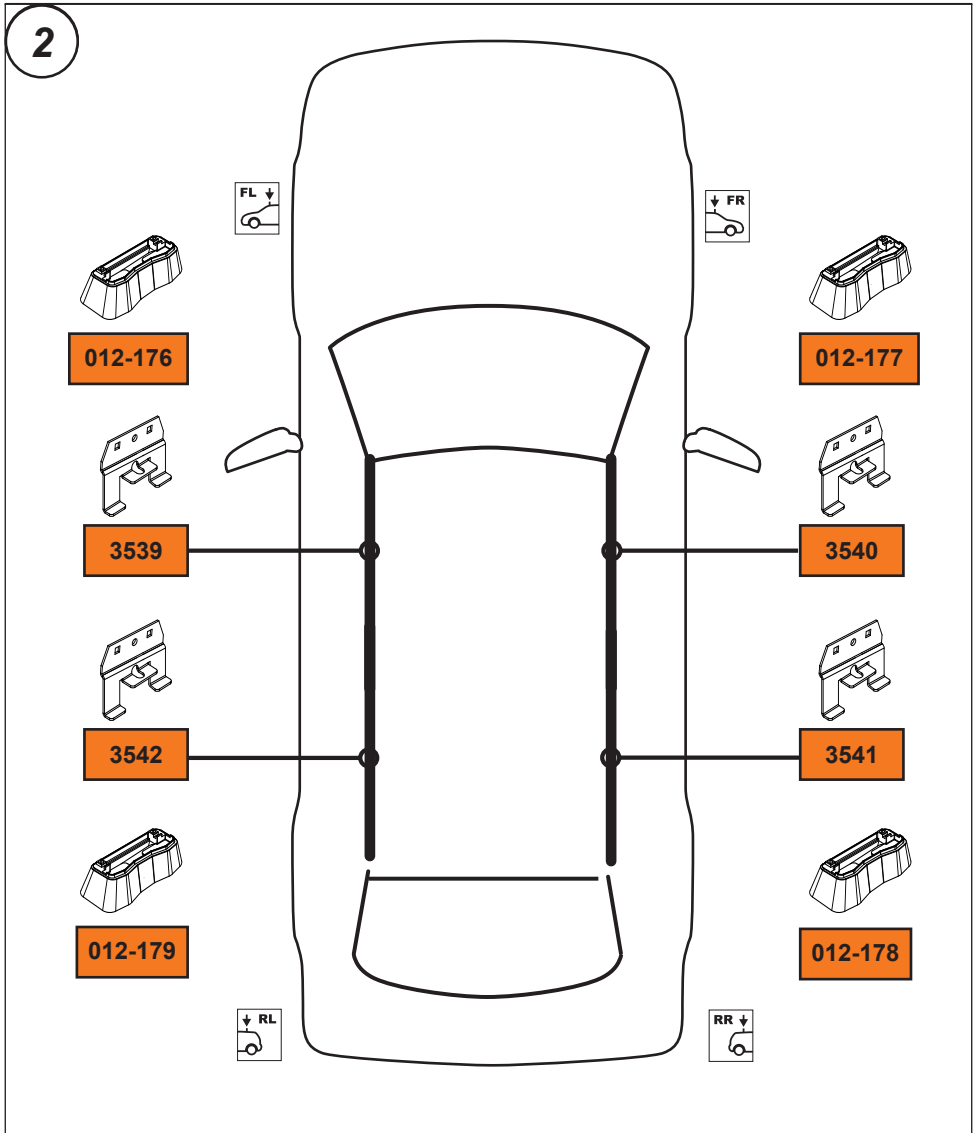
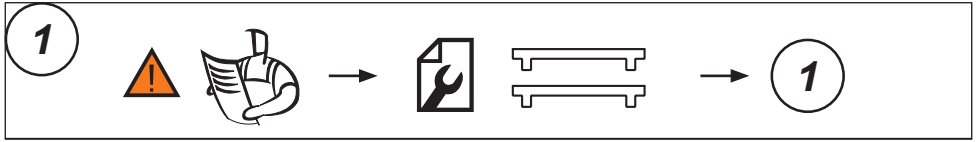

3. 

Cruz Airo Fuse



4,5,6,7

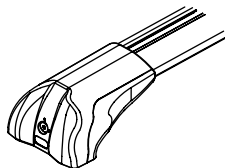

Cruz Airo FIX / Cruz Oplus S-FIX



8,9,10,11

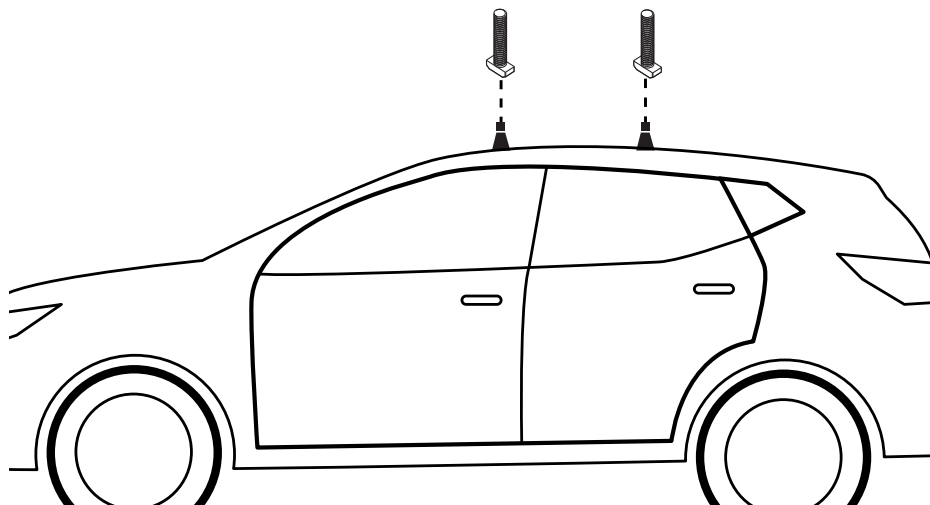

4. 

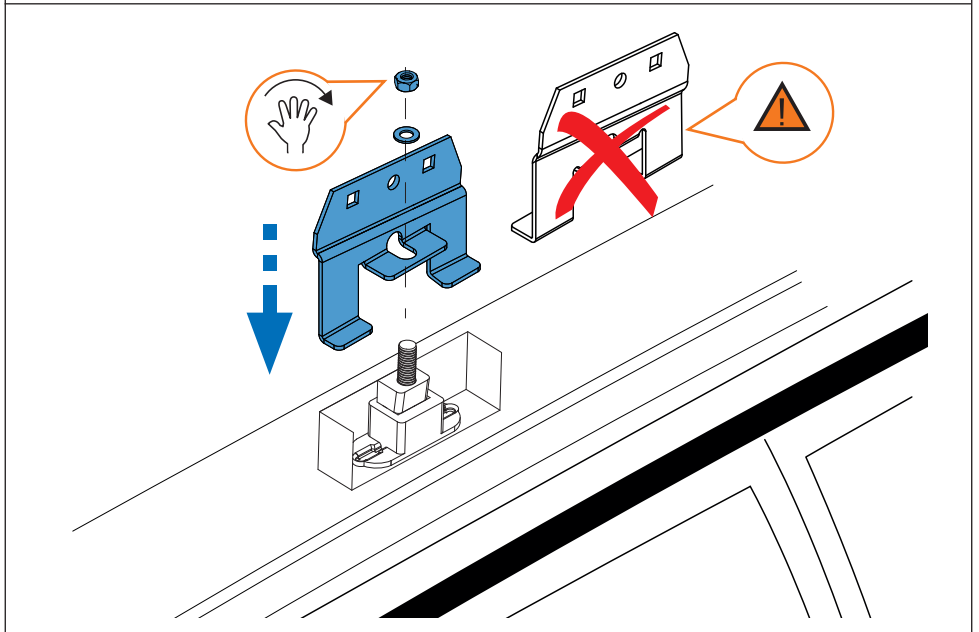
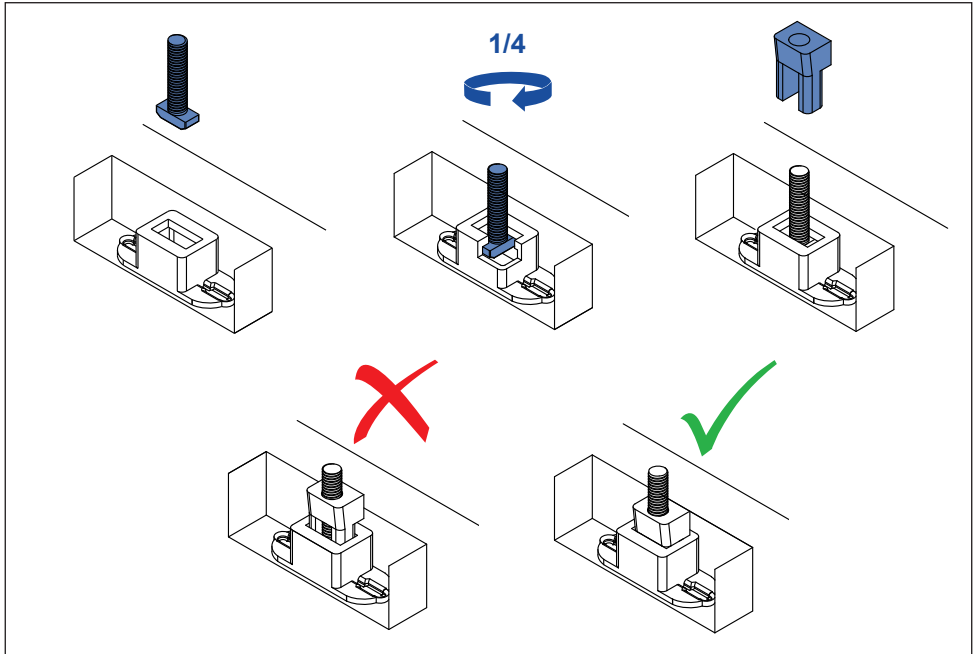
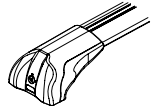

5. 

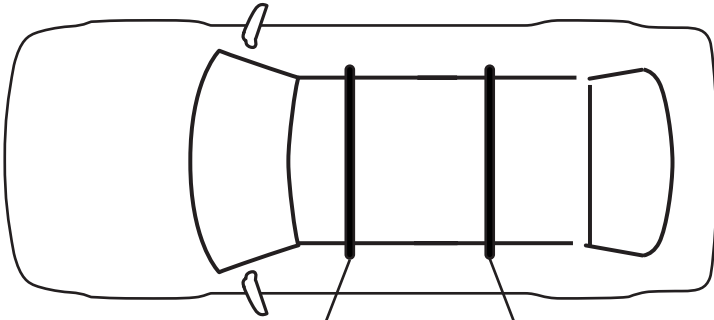
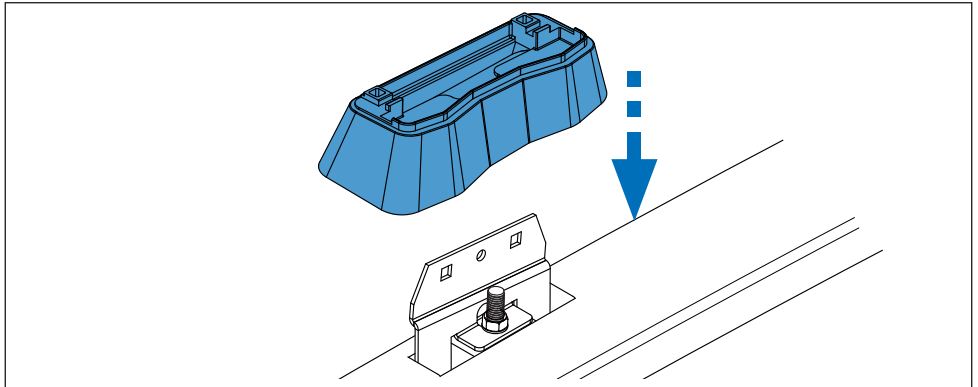
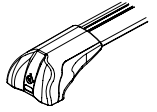

Cruz Airo Fuse 106

Cruz Airo Fuse 106

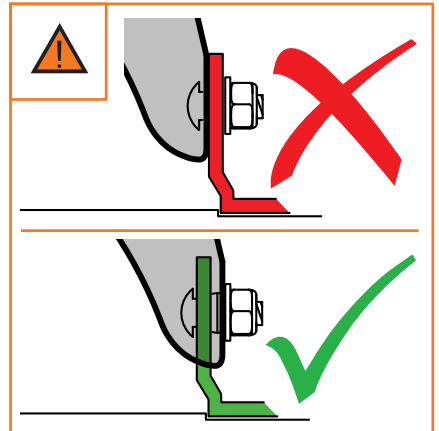
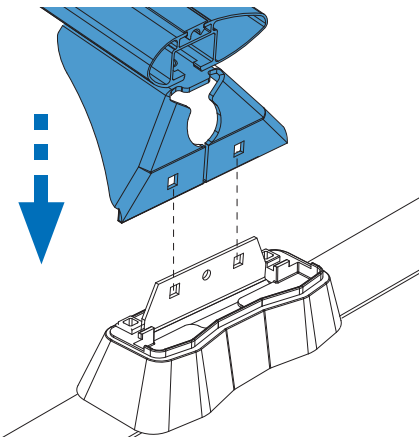

6. 

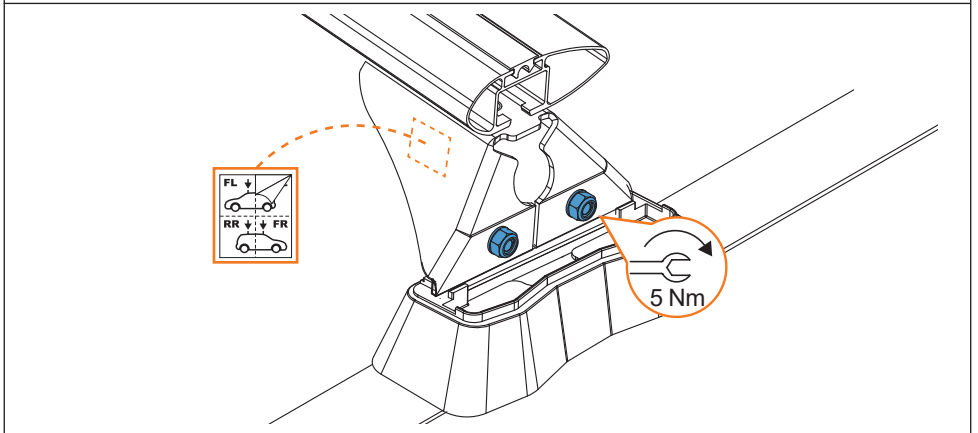
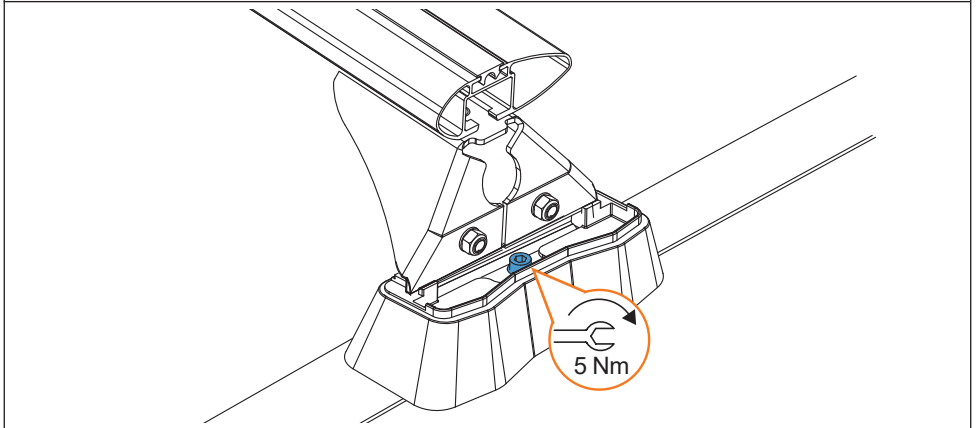
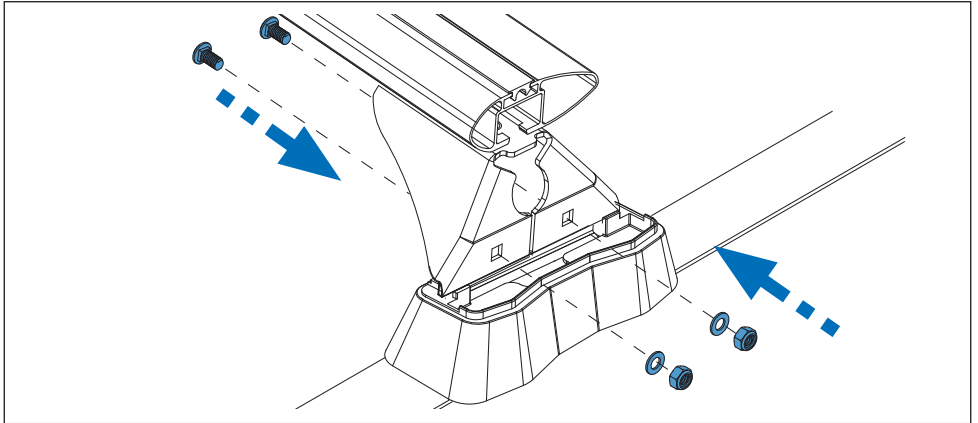
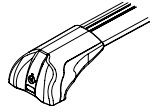

7. 

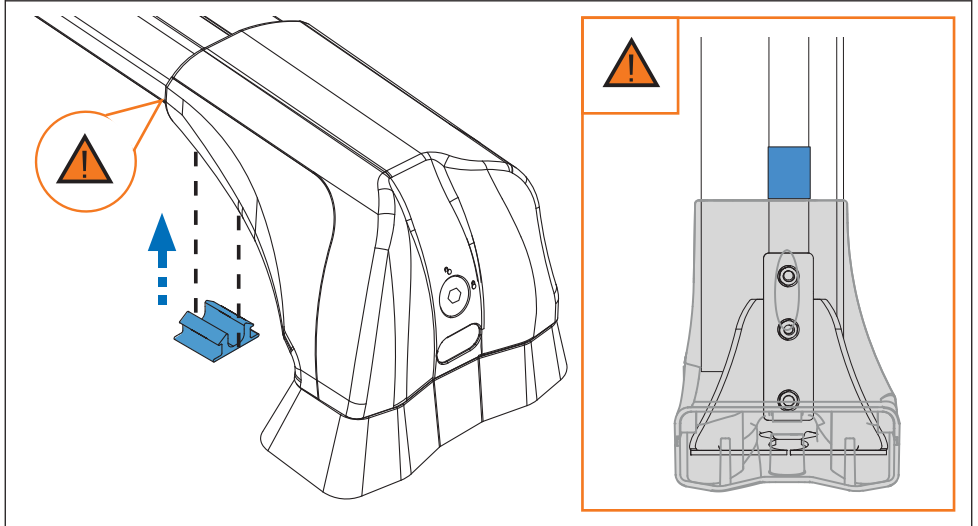
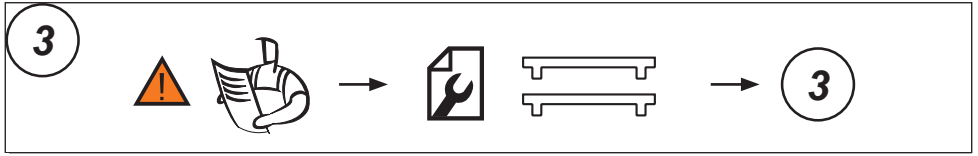
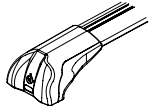

8. 

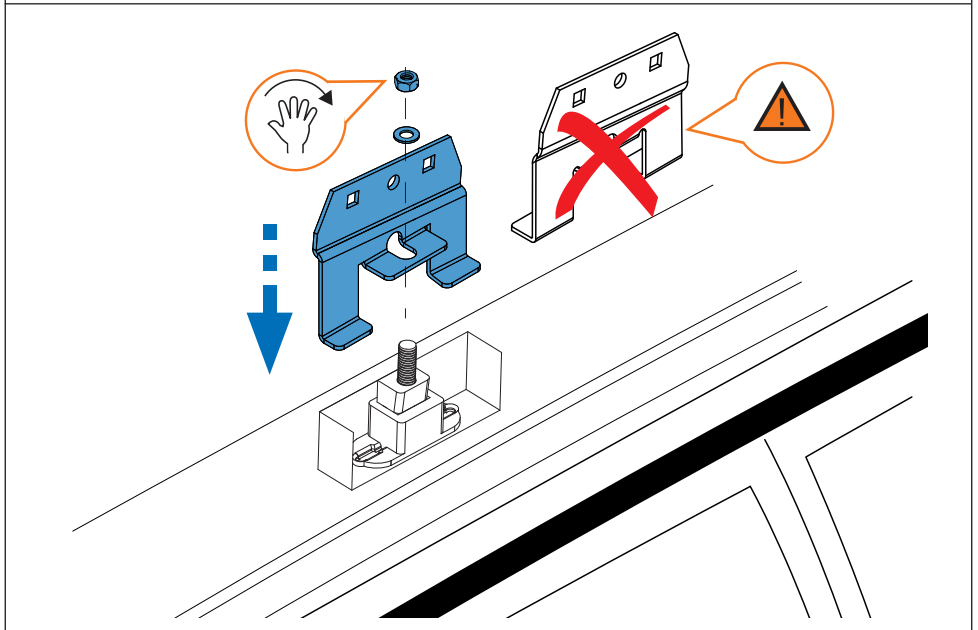
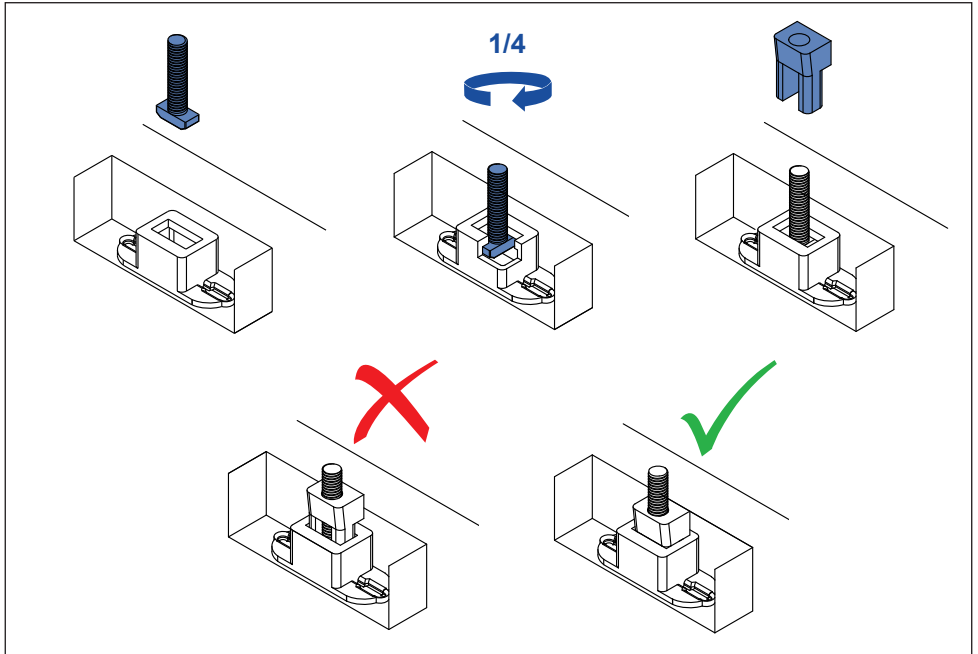
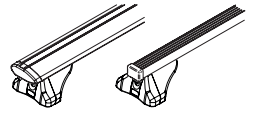

9. 

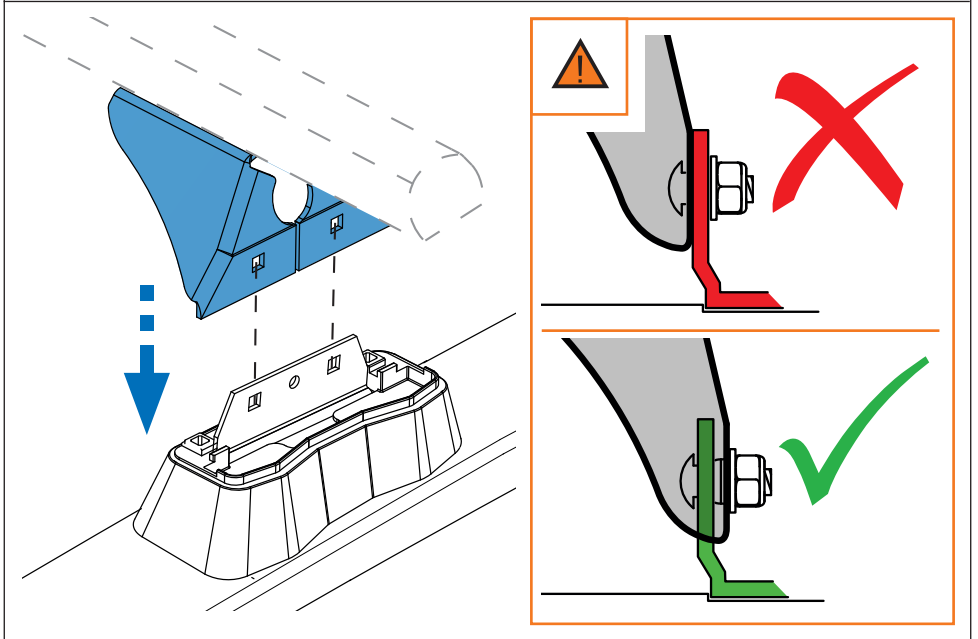
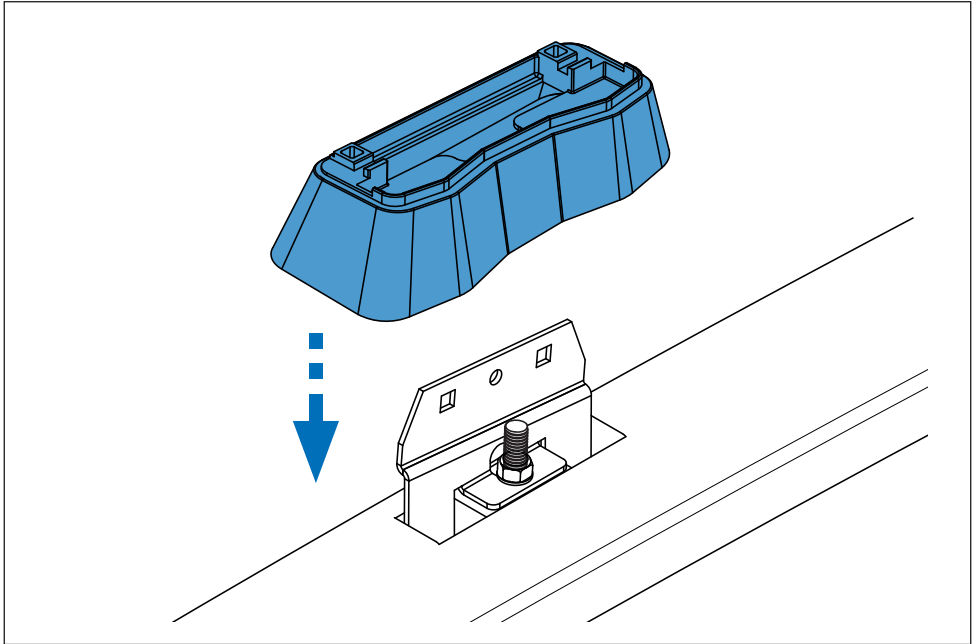
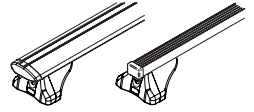

10.

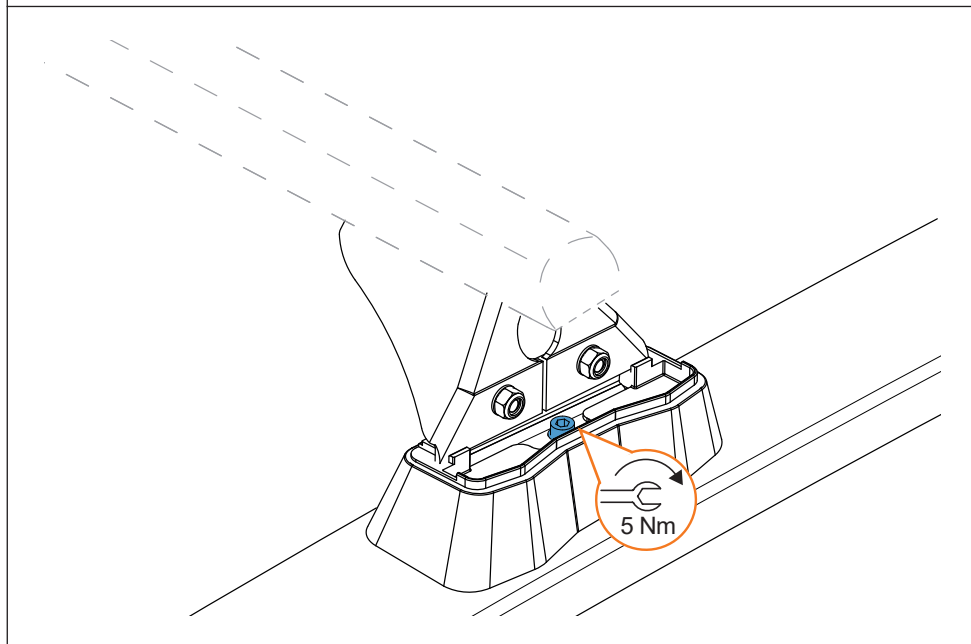
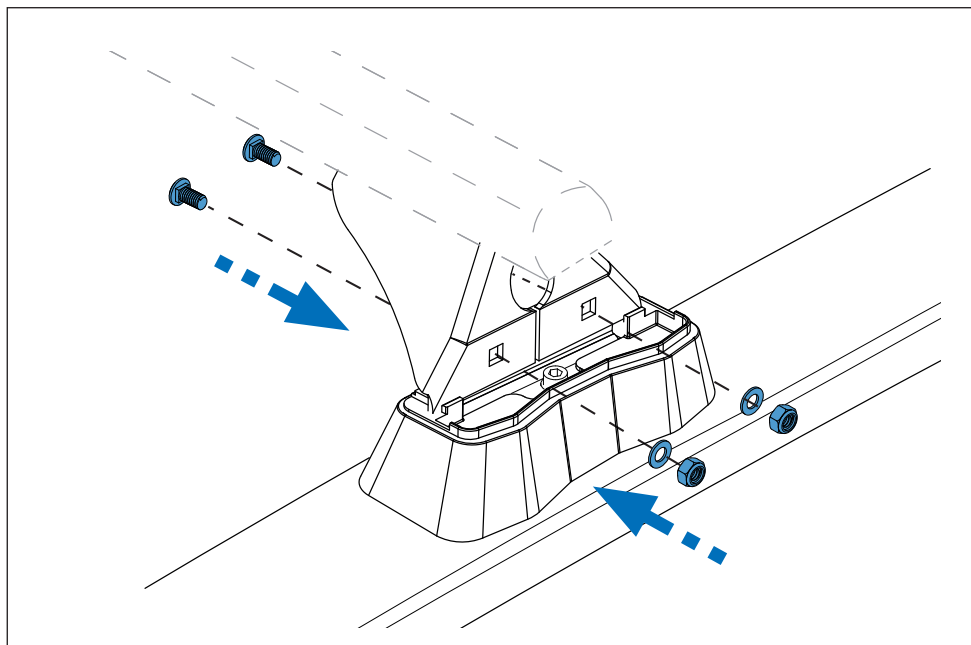
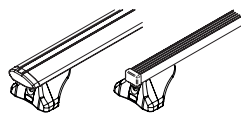

11.

