



- |       |   |                         |
|-------|---|-------------------------|
| (E)   | <b>Instrucción de montaje</b><br>¡Leer primero!           | Kit fijación            |
| (GB)  | <b>Assembly instructions</b><br>Read first!               | Fixation Kit            |
| (F)   | <b>Instruction de montage</b><br>Lire en premier!         | Kit fixation            |
| (D)   | <b>Montageanleitung</b><br>Zuerst lesen!                  | Stützfuß-Kit            |
| (PT)  | <b>Instruções de montagem</b><br>Ler primeiro!            | Kit fixação             |
| (PL)  | <b>Instrukcja montażu</b><br>Najpierw przeczytaj!         | Element mocujący        |
| (CZ)  | <b>Montážní návod</b><br>Čtěte pozorně!                   | Fixační kit             |
| (HU)  | <b>Szerelési Utasítás</b><br>Először olvassd el!          | Rögzítő készlet         |
| (RO)  | <b>Instructiuni de montaj</b><br>Intai cititi!            | Kit de fixare           |
| (HR)  | <b>Detaljne upute</b><br>Prvo pročitati!                  | Kit za montažu          |
| (GR)  | <b>Διαβάστε προσεκτικά τις</b><br>Οδηγίες Συναρμολόγησης! | Κιβώτιο (Kit) Επισκευής |
| (TR)  | <b>Öncelikle montaj:</b><br>Talimatlarını okuyunuz!       | Montaj kiti             |
| (RU)  | <b>Инструкции по монтажу</b><br>Сначала прочитайте!       | Крепежный комплект      |
| (I)   | <b>Istruzioni di montaggio</b><br>Leggere per primo!      | Kit di fissaggio        |
| (NL)  | <b>Montagehandleiding</b><br>Eerst lezen!                 | Bevestigingsset         |
| (SLO) | <b>Navodila za sestavljanje</b><br>Preberite!             | Kit za pričvrstitev     |

# 935-801

Lv7 2022-r4

Modelo-model:

## Optiplus

Lote-Lot-Lot-Lot:

**02-22**

Peso-Weight-Poids-Gewicht:

**0,79 kg**



Kit tipo (Certificación)  
Kit type (Certification)  
Kit type (Certificat)  
Kit Typ (Zertifizierung)

**A**

CEE - EEC type approval:

(E<sub>9</sub>) 26 R- 04 3015

CRUZBER SA  
ES-A14018311  
P.I. Las Salinas II  
14960 - Rute - Spain  
www.cruzber.com



1.



x1



x1



(018-041)

x1



(810-045)

x4



1x (2601)  
1x (2602)  
1x (2603)  
1x (2604)

x4



2x (012-060)  
2x (012-070)

x1



(001-820)

x4

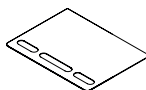

(018-098)



**Importante!**  
**Important!**  
**Important!**  
**Wichtig!**

**(E)** ¡Este Kit de fijación tiene que usarse con sistemas porta-cargas Cruz!

**(GB)** This fixation Kit must be used with Cruz roof rack systems!

**(F)** Cet Kit de fixation devra être utilisé avec les systèmes porte-charge Cruz!

**(D)** Dieser Stützfuß-Kit muß mit Cruz Dachträgersystemen benutzt werden!

**(PT)** Este Kit de fixação deve ser utilizado com os sistemas porta cargas Cruz!

**(PL)** Niniejszy element mocujący musi być używany z systemami bagażników dachowych firmy Cruz!

**(CZ)** Tento fixační kit musí být používán s nosným systémem Cruz!

**(HU)** Ez a rögzítő készlet csak a Cruz rendszerekkel használható!

**(RO)** Acest Kit de fixare, trebuie utilizat cu sisteme Cruz!

**(HR)** Kit za montažu mora biti korišten uz Cruz sistem krovnog nosača!

**(GR)** Το αξεσουάρ αυτό θα πρέπει να χρησιμοποιείται αποκλειστικά στα συστήματα μπαρών της Cruz!

**(TR)** Bu aksesuar mutlaka Cruz taşıma sistemleriyle kullanılmalıdır!

**(RU)** Крепежный комплект должен быть использован с багажной системой на крышу марки Cruz!

**(IT)** Questo kit di fissaggio deve essere usato con i portapacchi Cruz

**(NL)** Deze bevestigingsset moet worden gebruikt in combinatie met Cruz dakdrager systeem!

**(SLO)** Kit za pričvrstitev naj se uporablja le z izdelki iz asortimana strešnih košar Cruz!

2. 

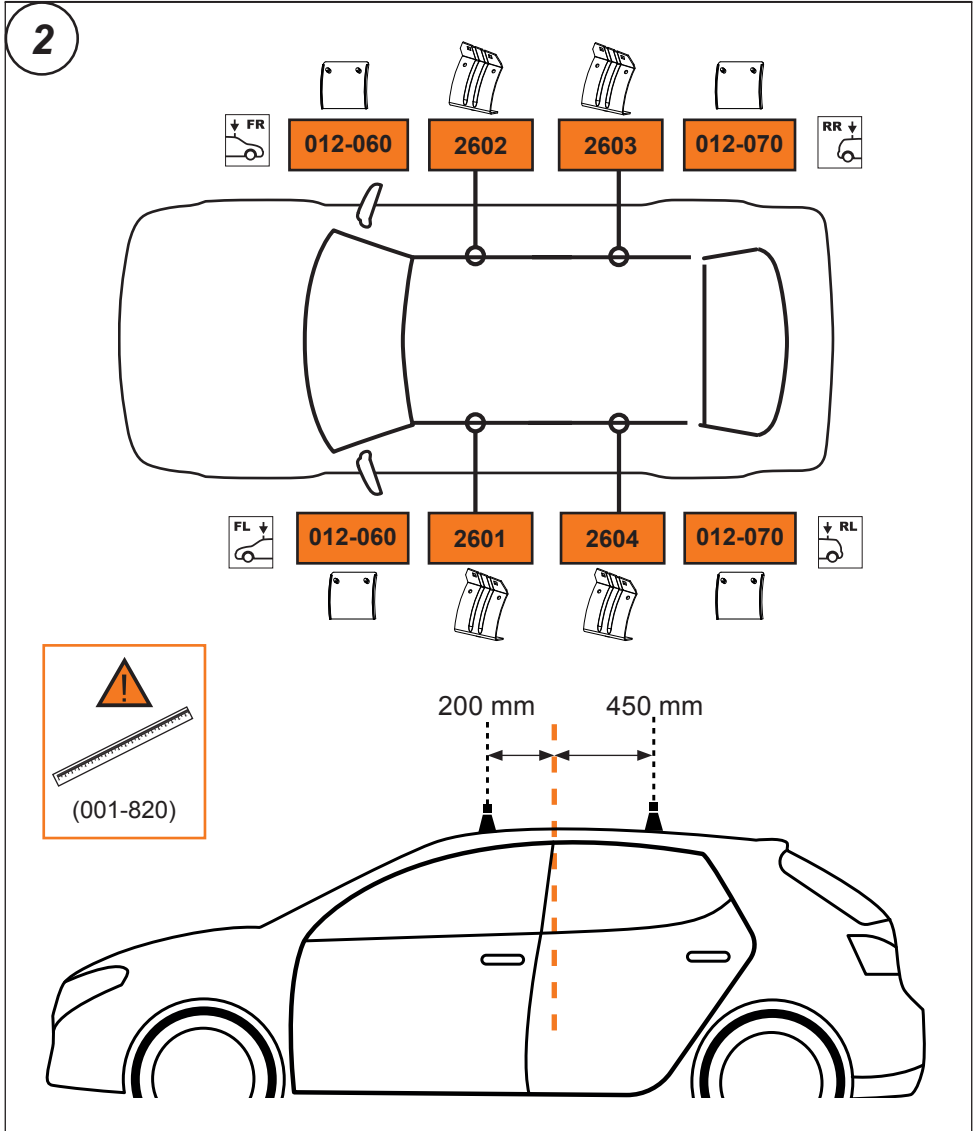

3. 



4. 

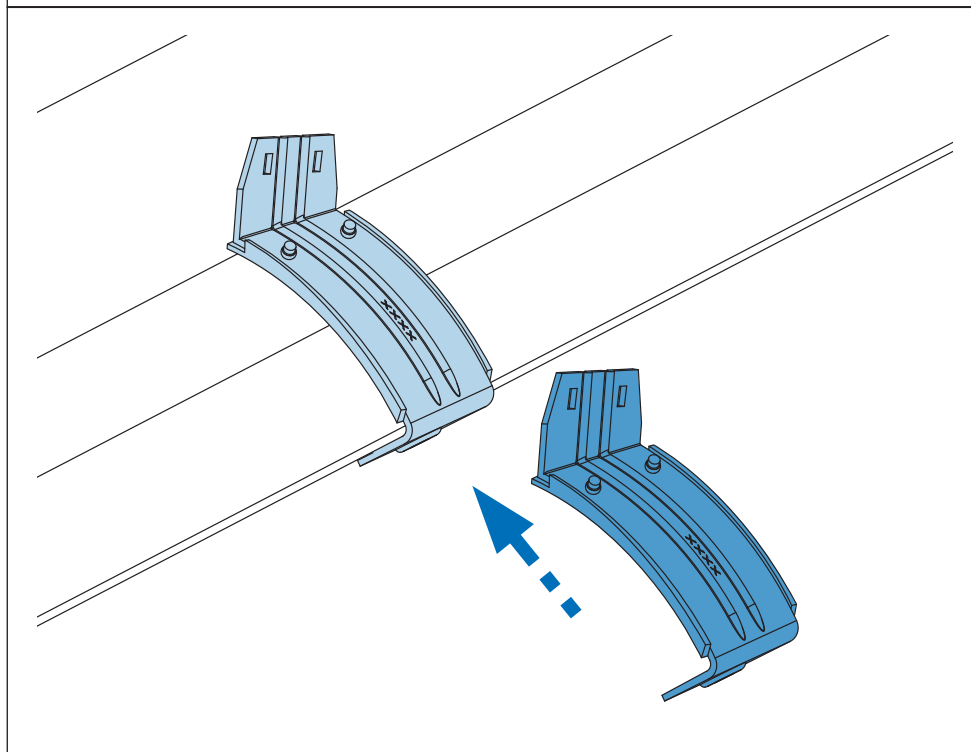
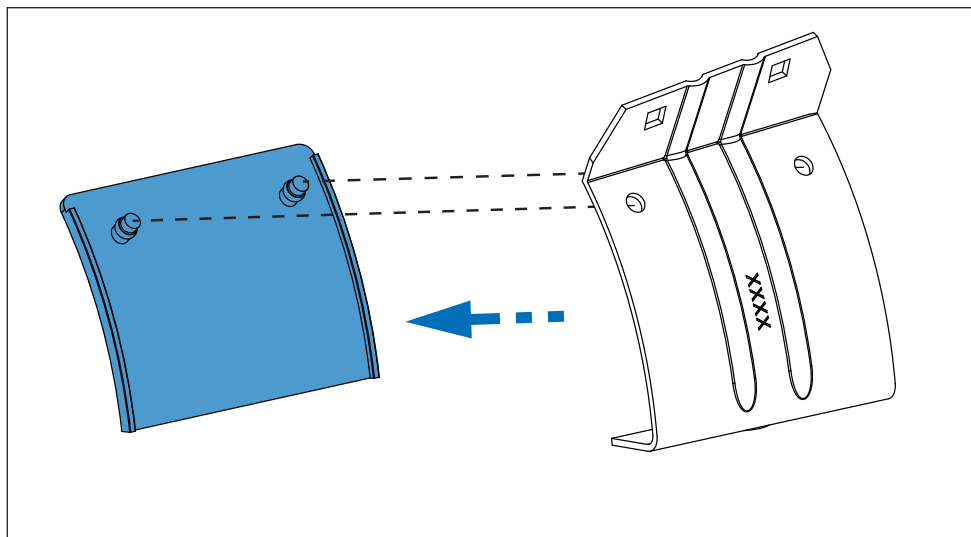

5. 



6. 

